

**DESCRIPTION** The 2SC2518 is NPN triple diffused transistor designed for switching regulator, DC-DC converter and ultrasonic appliance applications.

- FEATURES**
- High speed, high voltage switching.
  - Low collector saturation voltage.
  - Specified of reverse biased SOA with inductive loads.

**ABSOLUTE MAXIMUM RATINGS**

Maximum Temperatures

Storage Temperature . . . . . -55 to +150 °C  
 Junction Temperature . . . . . 150 °C Maximum

Maximum Power Dissipation (T<sub>c</sub> = 25 °C)  
 Total Power Dissipation . . . . . 40 W

Maximum Voltages and Currents(T<sub>a</sub> = 25 °C)

V <sub>CB0</sub>	Collector to Base Voltage . . . . .	500 V
V <sub>CE0</sub>	Collector to Emitter Voltage . . . . .	400 V
V <sub>EB0</sub>	Emitter to Base Voltage . . . . .	8.0 V
I <sub>C(DC)</sub>	Collector Current (DC) . . . . .	5.0 A
I <sub>C(pulse)</sub>	Collector Current (pulse)* . . . . .	10 A
I <sub>B(DC)</sub>	Base Current (DC) . . . . .	2.5 A

\* PW ≤ 300 μs, Duty Cycle ≤ 10 %

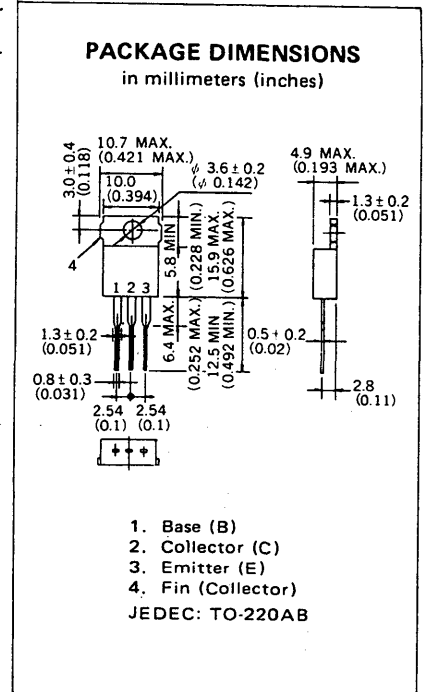

**ELECTRICAL CHARACTERISTICS (T<sub>a</sub> = 25 °C)**

SYMBOL	CHARACTERISTIC	MIN.	TYP.	MAX.	UNIT	TEST CONDITIONS
t <sub>on</sub>	Turn On Time			1.0	μs	I <sub>C</sub> = 2.0 A, I <sub>B1</sub> = -I <sub>B2</sub> = 0.4 A R <sub>L</sub> = 75 Ω, V <sub>CC</sub> = 150 V See Test Circuit.
t <sub>stg</sub>	Storage Time			2.5	μs	
t <sub>f</sub>	Fall Time			0.7	μs	
h <sub>FE1</sub>	DC Current Gain**	20		80	-	V <sub>CE</sub> = 5.0 V, I <sub>C</sub> = 0.5 A
h <sub>FE2</sub>	DC Current Gain**	10			-	V <sub>CE</sub> = 5.0 V, I <sub>C</sub> = 2.0 A
V <sub>CE(sat)</sub>	Collector Saturation Voltage**			1.0	V	I <sub>C</sub> = 2.0 A, I <sub>B</sub> = 0.4 A
V <sub>BE(sat)</sub>	Base Saturation Voltage**			1.5	V	I <sub>C</sub> = 2.0 A, I <sub>B</sub> = 0.4 A
V <sub>CEO(SUS)</sub>	Collector to Emitter Sustaining Voltage	400			V	I <sub>C</sub> = 2.0 A, I <sub>B</sub> = 0.4 A, L = 1 mH
V <sub>CEX(SUS)1</sub>	Collector to Emitter Sustaining Voltage	450			V	I <sub>C</sub> = 2.0 A, I <sub>B1</sub> = -I <sub>B2</sub> = 0.4 A, T <sub>a</sub> = 125 °C, L = 180 μH, Clamped
V <sub>CEX(SUS)2</sub>	Collector to Emitter Sustaining Voltage	400			V	I <sub>C</sub> = 4.0 A, I <sub>B1</sub> = 0.8 A, -I <sub>B2</sub> = 0.4 A, T <sub>a</sub> = 125 °C, L = 180 μH, Clamped
I <sub>CBO</sub>	Collector Cutoff Current			10	μA	V <sub>CB</sub> = 400 V, I <sub>E</sub> = 0
I <sub>CER</sub>	Collector Cutoff Current			1.0	mA	V <sub>CE</sub> = 400 V, R <sub>BE</sub> = 51 Ω, T <sub>a</sub> = 125 °C
I <sub>CEx1</sub>	Collector Cutoff Current			10	μA	V <sub>CE</sub> = 400 V, V <sub>BE(OFF)</sub> = -1.5 V
I <sub>CEx2</sub>	Collector Cutoff Current			1.0	mA	V <sub>CE</sub> = 400 V, V <sub>BE(OFF)</sub> = -1.5 V, T <sub>a</sub> = 125 °C
I <sub>EBO</sub>	Emitter Cutoff Current			10	μA	V <sub>EB</sub> = 5.0 V, I <sub>C</sub> = 0

\*\*Pulse Test : PW ≤ 350 μs, Duty Cycle ≤ 2 %/Pulsed

**Classification of h<sub>FE1</sub>**

Rank	M	L	K
Range	20 to 40	30 to 60	40 to 80

Test Conditions : V<sub>CE</sub> = 5.0 V, I<sub>C</sub> = 0.5 A

TYPICAL CHARACTERISTICS ( $T_a = 25^\circ\text{C}$ )

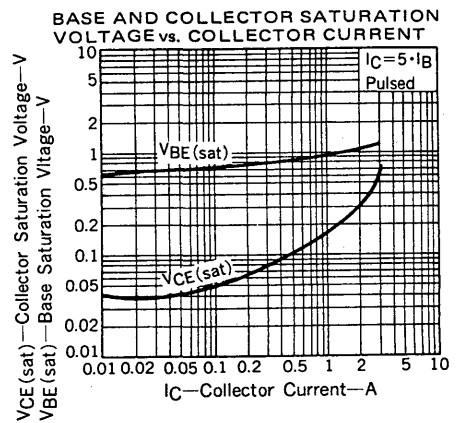
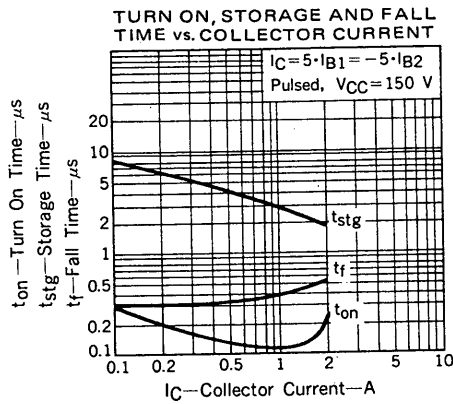
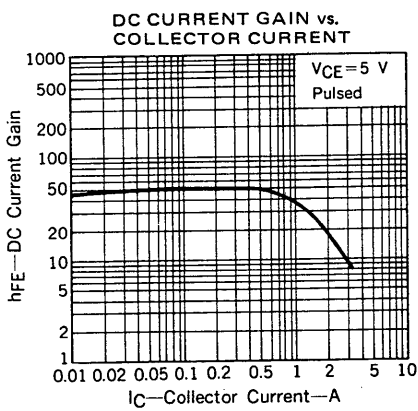
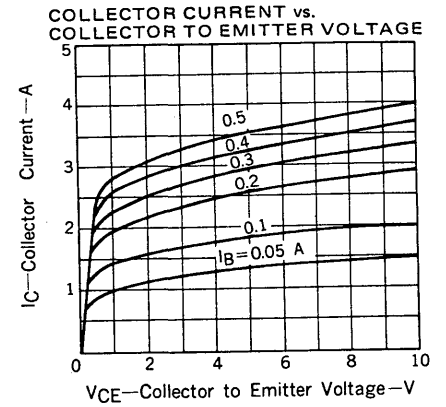
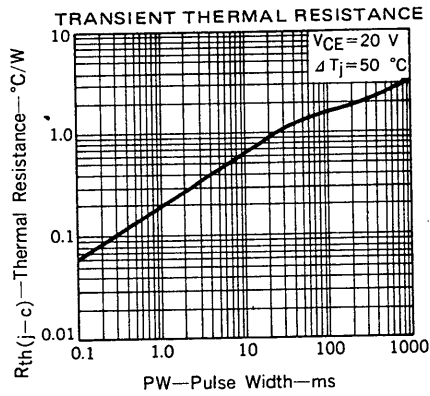
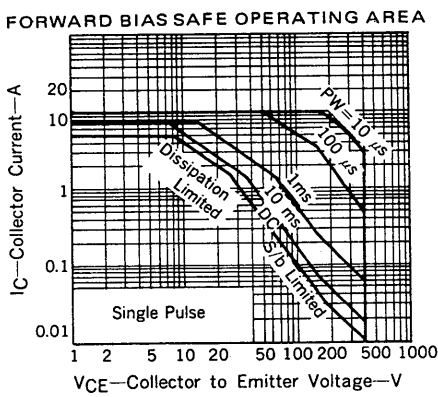
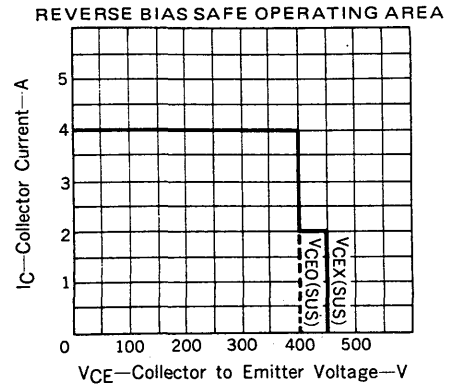
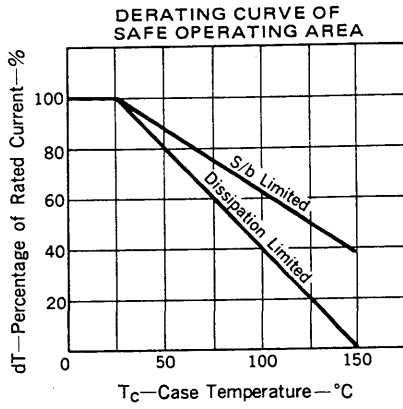
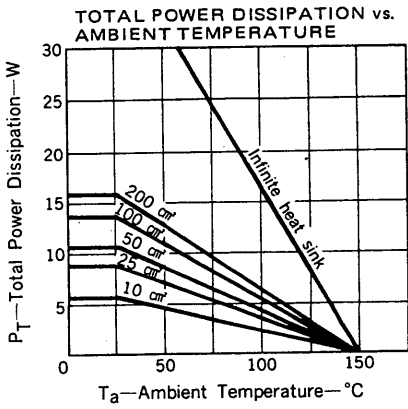

SWITCHING TIME ( $t_{on}$ ,  $t_{stg}$ ,  $t_f$ ) TEST CIRCUIT

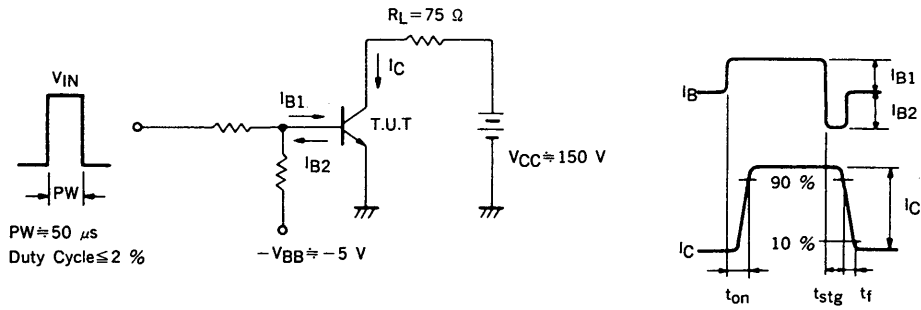

This datasheet has been downloaded from:

[www.DatasheetCatalog.com](http://www.DatasheetCatalog.com)

Datasheets for electronic components.